



21



21

**VALVOLE PER
RADIATORI**

RADIATOR VALVES

Le valvole per riscaldamento Tiemme sono composte da corpo in ottone EN12165-CW617N nichelato o cromato con tenute in elastomero etilene-propilene (EPDM) e volantino di regolazione in ABS. Sono idonee per impieghi con temperatura massima di 110°C e pressione di esercizio massima di 10 bar.

Tiemme radiator valves are assembled with nickel-plated or chrome-plated EN12165-CW617N brass with ethylene-propylene rubber (EPDM) seals and ABS head. Such valves are suitable for maximum temperature 110°C and maximum working pressure 10 bar.

SCelta ADATTATORI/ADAPTORs SELECTION

(VEDI/SEE Pag. 274 - 275 - 276 - 277 - 278)

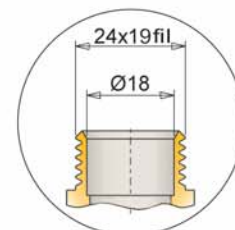
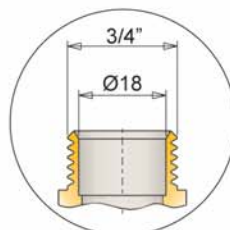
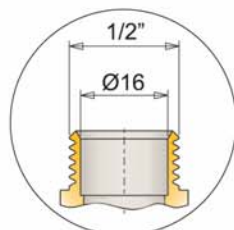
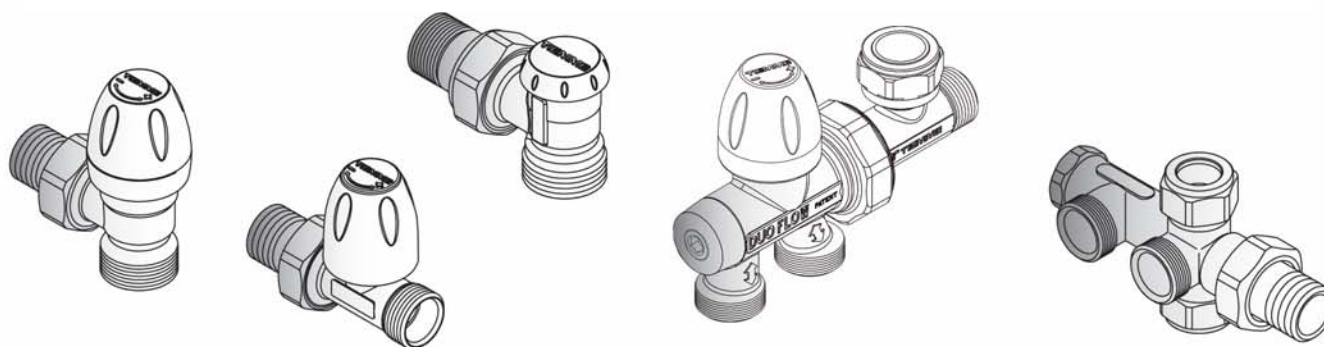

Art. 1668 (1/2")
per tubi multistrato
for multilayer pipe
Ø14x2,0
Ø16x2,0
Ø18x2,0
Ø20x2,0

Art. 1666
per tubi multistrato
for multilayer pipe
Ø14x2,0
Ø16x2,0
Ø18x2,0
Ø20x2,0

Art. 1666K
per tubi multistrato
for multilayer pipe
Ø16x2,0
Ø18x2,0
Ø20x2,0



Art. 1716
per tubi pe-x
for pe-x pipe
Ø16x1,8
Ø16x2,0
Ø20x1,9
Ø20x2,0

Art. 1716
per tubi pe-x
for pe-x pipe
Ø16x1,8
Ø16x2,0
Ø20x1,9
Ø20x2,0
Ø25x2,3

Art. 1716K
per tubi pe-x
for pe-x pipe
Ø16x1,8
Ø16x2,0
Ø20x1,9
Ø20x2,0



Art. 1635
per tubi multistrato
for multilayer pipe
Ø14x2,0
Ø16x2,0
Ø16x2,25

Art. 1636
per tubi multistrato
for multilayer pipe
Ø14x2,0 Ø16x2,0
Ø16x2,25 Ø17x2,0
Ø18x2,0 Ø20x2,0
Ø20x2,25 Ø20x2,5

Art. 1633K
per tubi multistrato
for multilayer pipe
Ø16x2,0
Ø18x2,0
Ø20x2,0



Art. 1435
per tubi pe-x
for pe-x pipe
Ø12x1,1 - Ø12x2,0
Ø14x2,0 - Ø15x2,5
Ø16x1,5 - Ø16x2,0
Ø16x2,2

Art. 1436
per tubi pe-x
for pe-x pipe
Ø12x2,0 - Ø14x2,0
Ø15x2,5 - Ø16x1,5
Ø16x2,0 - Ø16x2,2
Ø17x2,0 - Ø18x2,0
Ø18x2,5 - Ø20x2,0
Ø20x2,8

Art. 1433K
per tubi pe-x
for pe-x pipe
Ø15x2,5 - Ø16x2,0
Ø16x2,2 - Ø18x2,0
Ø18x2,5 - Ø20x2,0



Art. 1233 - 1235
per tubi in rame
for copper pipe
Ø10 - Ø12 - Ø14 - Ø16



Art. 1240
per tubi in rame
for copper pipe
Ø10 - Ø12 - Ø14
Ø15 - Ø16

Art. 1241
per tubi in rame
for copper pipe
Ø10 - Ø12 - Ø14
Ø15 - Ø16 - Ø18

Art. 1243K
per tubi in rame
for copper pipe
Ø15 - Ø16 - Ø18

VALVOLE TERMOSTATIZZABILI

VALVES WITH THERMOSTATIC OPTION



ART. 3301
Valvola a squadra termostattizzabile con attacco per tubo rame /Pe-x/ multistrato
Angle valve with thermostatic option for copper/Pe-x/multilayer pipe

CODICE Code	TIPO Size	ATTACCHI Connections	PREZZO Price €	CONF. Unit/Box
3301N0403	G 3/8"	1/2" - 16	9,18	10/60
3301N0404	G 1/2"	1/2" - 16	9,56	10/60
3301N0503	G 3/8"	3/4" - 18	15,51	10/60
3301N0504	G 1/2"	3/4" - 18	15,07	10/60
3301K1904	G 1/2"	24x19 fil (Ø18)	11,78	10/60
Versione con O-ring / O-ring version				
3301N0403R	G 3/8"	1/2" - 16	9,68	10/60
3301N0404R	G 1/2"	1/2" - 16	10,07	10/60
3301N0503R	G 3/8"	3/4" - 18	16,02	10/60
3301N0504R	G 1/2"	3/4" - 18	15,59	10/60
3301K1904R	G 1/2"	24x19 fil (Ø18)	12,85	10/60

■ versione cromata / chrome-plated version



ART. 3300
Valvola diritta termostattizzabile con attacco per tubo rame /Pe-x/ multistrato
Straight valve with thermostatic option for copper/Pe-x/multilayer pipe

CODICE Code	TIPO Size	ATTACCHI Connections	PREZZO Price €	CONF. Unit/Box
3300N0403	G 3/8"	1/2" - 16	10,45	10/60
3300N0404	G 1/2"	1/2" - 16	10,83	10/60
3300N0503	G 3/8"	3/4" - 18	12,12	10/60
3300N0504	G 1/2"	3/4" - 18	12,33	10/60
3300K1904	G 1/2"	24x19 fil (Ø18)	13,32	10/60
Versione con O-ring / O-ring version				
3300N0403R	G 3/8"	1/2" - 16	10,96	10/60
3300N0404R	G 1/2"	1/2" - 16	11,34	10/60
3300N0503R	G 3/8"	3/4" - 18	12,67	10/60
3300N0504R	G 1/2"	3/4" - 18	12,88	10/60
3300K1904R	G 1/2"	24x19 fil (Ø18)	14,04	10/60

■ versione cromata / chrome-plated version



ART. 3306
Valvola a squadra termostattizzabile con attacco per tubo ferro
Angle valve with thermostatic option for iron pipe

CODICE Code	TIPO Size	PREZZO Price €	CONF. Unit/Box
3306N0303	G 3/8"	10,71	10/60
3306N0404	G 1/2"	11,09	10/60
3306N0505	G 3/4"	17,71	10/60
Versione con O-ring / O-ring version			
3306N0303R	G 3/8"	11,22	10/60
3306N0404R	G 1/2"	11,59	10/60
3306N0505R	G 3/4"	18,23	10/60



ART. 3305
Valvola diritta termostattizzabile con attacco per tubo ferro
Straight valve with thermostatic option for iron pipe

CODICE Code	TIPO Size	PREZZO Price €	CONF. Unit/Box
3305N0303	G 3/8"	11,34	10/60
3305N0404	G 1/2"	12,11	10/60
3305N0505	G 3/4"	19,25	10/60
Versione con O-ring / O-ring version			
3305N0303R	G 3/8"	11,85	10/60
3305N0404R	G 1/2"	12,61	10/60
3305N0505R	G 3/4"	19,75	10/60



ART. 3303
Valvola a squadra termostattizzabile con attacco per tubo rame /Pe-x/ multistrato. Versione con cappuccio di protezione
Angle valve with thermostatic option for copper/Pe-x/multilayer pipe with protection cap

CODICE Code	TIPO Size	ATTACCHI Connections	PREZZO Price €	CONF. Unit/Box
3303N0403	G 3/8"	1/2" - 16	8,66	10/60
3303N0404	G 1/2"	1/2" - 16	9,05	10/60
3303N0503	G 3/8"	3/4" - 18	14,73	10/60
3303N0504	G 1/2"	3/4" - 18	14,32	10/60
Versione con O-ring / O-ring version				
3303N0403R	G 3/8"	1/2" - 16	9,18	10/60
3303N0404R	G 1/2"	1/2" - 16	9,56	10/60
3303N0503R	G 3/8"	3/4" - 18	15,22	10/60
3303N0504R	G 1/2"	3/4" - 18	14,81	10/60



ART. 3302
Valvola diritta termostattizzabile con attacco per tubo rame /Pe-x/ multistrato. Versione con cappuccio di protezione
Straight valve with thermostatic option for copper/Pe-x/multilayer pipe with protection cap

CODICE Code	TIPO Size	ATTACCHI Connections	PREZZO Price €	CONF. Unit/Box
3302N0403	G 3/8"	1/2" - 16	9,94	10/60
3302N0404	G 1/2"	1/2" - 16	10,33	10/60
3302N0503	G 3/8"	3/4" - 18	11,57	10/60
3302N0504	G 1/2"	3/4" - 18	11,77	10/60
Versione con O-ring / O-ring version				
3302N0403R	G 3/8"	1/2" - 16	10,45	10/60
3302N0404R	G 1/2"	1/2" - 16	10,83	10/60
3302N0503R	G 3/8"	3/4" - 18	12,12	10/60
3302N0504R	G 1/2"	3/4" - 18	12,33	10/60

VALVOLE TERMOSTATIZZABILI VALVES WITH THERMOSTATIC OPTION



ART. 3308
Valvola a squadra termostattizzabile con attacco per tubo ferro. Versione con cappuccio di protezione
Angle valve with thermostatic option for iron pipe with protection cap

CODICE Code	TIPO Size	PREZZO Price €	CONF. Unit/Box
3308N0303	G 3/8"	10,20	10/60
3308N0404	G 1/2"	10,57	10/60
3308N0505	G 3/4"	17,21	10/60
Versione con O-ring / O-ring version			
3308N0303R	G 3/8"	10,71	10/60
3308N0404R	G 1/2"	11,09	10/60
3308N0505R	G 3/4"	17,73	10/60



ART. 3307
Valvola diritta termostattizzabile con attacco per tubo ferro. Versione con cappuccio di protezione
Straight valve with thermostatic option for iron pipe with protection cap

CODICE Code	TIPO Size	PREZZO Price €	CONF. Unit/Box
3307N0303	G 3/8"	10,83	10/60
3307N0404	G 1/2"	11,59	10/60
3307N0505	G 3/4"	18,74	10/60
Versione con O-ring / O-ring version			
3307N0303R	G 3/8"	11,34	10/60
3307N0404R	G 1/2"	12,11	10/60
3307N0505R	G 3/4"	19,26	10/60

DETTENTORI PER RADIATORI LOCKSHIELDS FOR RADIATORS



ART. 3331
Detentore a squadra con attacco per tubo rame /Pe-x/ multistrato
Angle lockshield for copper/Pe-x/ multilayer pipe

CODICE Code	TIPO Size	ATTACCHI Connections	PREZZO Price €	CONF. Unit/Box
3331N0403	G 3/8"	1/2" - 16	7,12	10/60
3331N0404	G 1/2"	1/2" - 16	7,19	10/60
3331N0503	G 3/8"	3/4" - 18	13,18	10/60
3331N0504	G 1/2"	3/4" - 18	12,81	10/60
■ 3331K1904	G 1/2"	24x19 fil (Ø18)	13,45	1/60
Versione con O-ring / O-ring version				
3331N0403R	G 3/8"	1/2" - 16	7,72	10/60
3331N0404R	G 1/2"	1/2" - 16	7,80	10/60
3331N0503R	G 3/8"	3/4" - 18	13,62	10/60
3331N0504R	G 1/2"	3/4" - 18	13,25	10/60
■ 3331K1904R	G 1/2"	24x19 fil (Ø18)	13,91	1/60

■ versione cromata / chrome-plated version



ART. 3330
Detentore diritto con attacco per tubo rame /Pe-x/ multistrato
Straight lockshield for copper/Pe-x/ multilayer pipe

CODICE Code	TIPO Size	ATTACCHI Connections	PREZZO Price €	CONF. Unit/Box
3330N0403	G 3/8"	1/2" - 16	7,72	10/60
3330N0404	G 1/2"	1/2" - 16	7,80	10/60
3330N0503	G 3/8"	3/4" - 18	9,00	10/60
3330N0504	G 1/2"	3/4" - 18	9,00	10/60
■ 3330K1904	G 1/2"	24x19 fil (Ø18)	9,45	1/60
Versione con O-ring / O-ring version				
3330N0403R	G 3/8"	1/2" - 16	8,33	10/60
3330N0404R	G 1/2"	1/2" - 16	8,42	10/60
3330N0503R	G 3/8"	3/4" - 18	9,64	10/60
3330N0504R	G 1/2"	3/4" - 18	9,64	10/60
■ 3330K1904R	G 1/2"	24x19 fil (Ø18)	10,13	1/60

■ versione cromata / chrome-plated version

DETENTORI PER RADIATORI

LOCKSHIELDS FOR RADIATORS



ART. 3336

Detentore a squadra con attacco tubo ferro
Angle lockshield for iron pipe

CODICE Code	TIPO Size	PREZZO Price €	CONF. Unit/Box
3336N0303	G 3/8"	8,15	10/60
3336N0404	G 1/2"	7,80	10/60
3336N0505	G 3/4"	18,42	10/60
■ 3336K0404	G 1/2"	8,19	1/60
■ 3336K0505	G 3/4"	19,34	1/60
Versione con O-ring / O-ring version			
3336N0303R	G 3/8"	8,63	10/60
3336N0404R	G 1/2"	8,42	10/60
3336N0505R	G 3/4"	19,01	10/60
■ 3336K0404R	G 1/2"	8,84	1/60
■ 3336K0505R	G 3/4"	19,96	1/60

■ versione cromata / chrome-plated version



ART. 3335

Detentore diritto con attacco per tubo ferro
Straight lockshield for iron pipe

CODICE Code	TIPO Size	PREZZO Price €	CONF. Unit/Box
3335N0303	G 3/8"	8,54	10/60
3335N0404	G 1/2"	8,33	10/60
3335N0505	G 3/4"	19,38	10/60
■ 3335K0404	G 1/2"	8,75	1/60
■ 3335K0505	G 3/4"	20,34	1/60
Versione con O-ring / O-ring version			
3335N0303R	G 3/8"	9,19	10/60
3335N0404R	G 1/2"	8,95	10/60
3335N0505R	G 3/4"	19,99	10/60
■ 3335K0404R	G 1/2"	9,40	1/60
■ 3335K0505R	G 3/4"	20,98	1/60

■ versione cromata / chrome-plated version

VALVOLE PER TERMOARREDO

CHROME-PLATED RADIATOR VALVES



ART. 3301C

Valvola a squadra termostattizzabile con attacco per tubo rame / Pe-x / multistrato - Versione cromata lucida
Angle valve with thermostatic option for copper/Pe-x/multilayer pipe - Bright chrome-plated

CODICE Code	TIPO Size	ATTACCHI Connections	PREZZO Price €	CONF. Unit/Box
3301C0403	G 3/8"	1/2" - 16	16,69	10/60
3301C0404	G 1/2"	1/2" - 16	17,46	10/60



ART. 3300C

Valvola diretta termostattizzabile con attacco per tubo rame / Pe-x / multistrato - Versione cromata lucida
Straight valve with thermostatic option for copper/Pe-x/multilayer pipe - Bright chrome-plated

CODICE Code	TIPO Size	ATTACCHI Connections	PREZZO Price €	CONF. Unit/Box
3300C0403	G 3/8"	1/2" - 16	19,50	10/60
3300C0404	G 1/2"	1/2" - 16	20,39	10/60



ART. 3306C

Valvola a squadra termostattizzabile con attacco per tubo ferro - Versione cromata lucida
Angle valve with thermostatic option, for iron pipe. - Bright chrome-plated

CODICE Code	TIPO Size	PREZZO Price €	CONF. Unit/Box
3306C0303	G 3/8"	18,74	10/60
3306C0404	G 1/2"	20,91	10/60



ART. 3305C

Valvola diretta termostattizzabile con attacco per tubo ferro - Versione cromata lucida
Straight valve with thermostatic option for iron pipe - Bright chrome-plated

CODICE Code	TIPO Size	PREZZO Price €	CONF. Unit/Box
3305C0303	G 3/8"	19,75	10/60
3305C0404	G 1/2"	22,30	10/60



ART. 1240C

Per tubo rame/for copper pipe
Dado cromato + ogiva incorporata per attacco 1/2" x 16
Chrome-plated nut with brass and rubber rings for rif. 1/2" x 16

CODICE Code	TIPO Size	PREZZO Price €	CONF. Unit/Box
1240C001004	10 x 1/2"	3,53	10/400
1240C001204	12 x 1/2"	3,53	10/400
1240C001404	14 x 1/2"	3,53	10/400
1240C001504	15 x 1/2"	3,53	10/400
1240C001604	16 x 1/2"	3,80	10/400



ART. 1635C

Per tubo multistrato for multilayer pipe
Adattatore cromato per attacchi 1/2" x 16
Chrome-plated adapter for 1/2" x 16 connections

CODICE Code	TIPO Size	PREZZO Price €	CONF. Unit/Box
1635C161404	14 sp 2,0 x 1/2"	3,92	10/350
1635C001604	16 sp 2,0 x 1/2"	3,92	10/300
1635C1622504	16 sp 2,25 x 1/2"	3,92	10/300

DETENTORI PER TERMOARREDO

CHROME-PLATED PANEL LOCKSHIELDS



ART. 3331C

Detentore a squadra con attacco per tubo rame/Pe-x/multistrato - Versione cromata lucida
Angle lockshield for copper/Pe-x/multilayer pipe - Bright chrome-plated

CODICE Code	TIPO Size	ATTACCHI Connections	PREZZO Price €	CONF. Unit/Box
3331C0403	G 3/8"	1/2" - 16	15,58	10/60
3331C0404	G 1/2"	1/2" - 16	15,72	10/60



ART. 3330C

Detentore dritto con attacco per tubo rame/Pe-x/multistrato - Versione cromata lucida
Straight lockshield for copper/Pe-x/multilayer pipe - Bright chrome-plated

CODICE Code	TIPO Size	ATTACCHI Connections	PREZZO Price €	CONF. Unit/Box
3330C0403	G 3/8"	1/2" - 16	15,58	10/60
3330C0404	G 1/2"	1/2" - 16	15,72	10/60



ART. 3336C

Detentore a squadra con attacco per tubo ferro - Versione cromata lucida
Angle lockshield for iron pipe - Bright chrome-plated

CODICE Code	TIPO Size	PREZZO Price €	CONF. Unit/Box
3336C0303	G 3/8"	17,54	10/60
3336C0404	G 1/2"	17,54	10/60



ART. 3335C

Detentore dritto con attacco tubo ferro - Versione cromata lucida
Straight lockshield for iron pipe - Bright chrome-plated

CODICE Code	TIPO Size	PREZZO Price €	CONF. Unit/Box
3335C0303	G 3/8"	17,54	10/60
3335C0404	G 1/2"	17,54	10/60

COMANDI TERMOSTATICI

THERMOSTATIC CONTROLS

Testa
termostatica
Serie
Thermostatic head
Series



Heating
Controller



ART. 9557

Testa termostatica con elemento sensibile a liquido incorporato
Thermostatic head with liquid sensitive element

CODICE Code	ATTACCO Connection	PREZZO Price €	CONF. Unit/Box
9557T3	M30 x 1,5	13,68	1/30



ART. 9557C

Testa termostatica con elemento sensibile a liquido incorporato cromata
Thermostatic head with liquid sensitive element chrome-plated

CODICE Code	ATTACCO Connection	PREZZO Price €	CONF. Unit/Box
9557T3C	M30 x 1,5	17,50	1/30



ART. 9557CA

Testa termostatica con elemento sensibile a liquido incorporato cromata/bianco
Thermostatic head with liquid sensitive element chrome-plated/white

CODICE Code	ATTACCO Connection	PREZZO Price €	CONF. Unit/Box
9557T3CA	M30 x 1,5	17,12	1/30



ART. 9557CB

Testa termostatica con elemento sensibile a liquido incorporato bianco/cromata
Thermostatic head with liquid sensitive element white/chrome-plated

CODICE Code	ATTACCO Connection	PREZZO Price €	CONF. Unit/Box
9557T3CB	M30 x 1,5	17,12	1/30



ART. 9558

Testa termostatica con elemento sensibile a liquido a distanza (lunghezza capillare 2 m)
Thermostatic head with distance liquid sensitive element (length 2 m)

CODICE Code	ATTACCO Connection	PREZZO Price €	CONF. Unit/Box
9558T3		51,30	1/1



ART. 9560

Anello antimanomissione per testa termostatica
Tamper-proof cap for thermostatic head

CODICE Code	TIPO Size	PREZZO Price €	CONF. Unit/Box
9560T1	unica - single	6,03	1/1

KIT VALVOLE TERMOSTATIZZABILI

KIT VALVES WITH THERMOSTATIC OPTION



ART. 3303KIT

Kit 3 pezzi composto da: valvola a squadra, testa termostatica e detentore con attacco per tubo rame / Pe-x / multistrato
3-pieces kit composed of: angle valve, thermostatic head and lockshields for copper/Pe-x/multilayer pipe

CODICE Code	TIPO Size	ATTACCHI Connections	PREZZO Price €	CONF. Unit/Box
3303N0403KIT	G 3/8"	1/2" - 16	25,92	1/10
3303N0404KIT	G 1/2"	1/2" - 16	26,33	1/10
3303N0503KIT	G 3/8"	3/4" - 18	36,60	1/10
3303N0504KIT	G 1/2"	3/4" - 18	35,91	1/10



ART. 3302KIT

Kit 3 pezzi composto da: valvola dritta, testa termostatica e detentore con attacco per tubo rame / Pe-x / multistrato
3-pieces kit composed of: straight valve, thermostatic head and lockshields for copper/Pe-x/multilayer pipe

CODICE Code	TIPO Size	ATTACCHI Connections	PREZZO Price €	CONF. Unit/Box
3302N0403KIT	G 3/8"	1/2" - 16	27,57	1/10
3302N0404KIT	G 1/2"	1/2" - 16	27,99	1/10
3302N0503KIT	G 3/8"	3/4" - 18	30,13	1/10
3302N0504KIT	G 1/2"	3/4" - 18	30,31	1/10



ART. 3308KIT

Kit 3 pezzi composto da: valvola a squadra, testa termostatica e detentore con attacco per tubo ferro
3-pieces kit composed of: angle valve, thermostatic head and lockshields for iron pipe

CODICE Code	TIPO Size	PREZZO Price €	CONF. Unit/Box
3308N0303KIT	G 3/8"	28,18	1/10
3308N0404KIT	G 1/2"	28,21	1/10
3308N0505KIT	G 3/4"	43,39	1/10



ART. 3307KIT

Kit a 3 pezzi composto da: valvola dritta, testina termostatica e detentore dritto con attacco per tubo ferro
3-pieces kit composed of: straight valve, thermostatic head and lockshield for iron pipe

CODICE Code	TIPO Size	PREZZO Price €	CONF. Unit/Box
3307N0303KIT	G 3/8"	29,09	1/10
3307N0404KIT	G 1/2"	29,57	1/10
3307N0505KIT	G 3/4"	45,58	1/10

VALVOLE MANUALI PER RADIATORI SERIE "MAXIMA"

"MAXIMA" MANUAL VALVES FOR RADIATOR



ART. 3321

Valvola a squadra manuale con attacco per tubo rame / Pe-x / multistrato.
Versione cromata
Manual valve with thermostatic option for copper/Pe-x/multilayer pipe.
Chrome-plated version

CODICE Code	TIPO Size	ATTACCHI Connections	PREZZO Price €	CONF. Unit/Box
3321K1904	G 1/2"	24x19 fil (Ø18)	7,56	1/60
Versione con O-ring / O-ring version				
3321K1904R	G 1/2"	24x19 fil (Ø18)	8,24	1/60



ART. 3320

Valvola manuale dritta con attacco per tubo rame / Pe-x / multistrato.
Versione cromata
Straight manual valve with thermostatic option for copper/Pe-x/multilayer pipe.
Chrome-plated version

CODICE Code	TIPO Size	ATTACCHI Connections	PREZZO Price €	CONF. Unit/Box
3320K1904	G 1/2"	24x19 fil (Ø18)	7,91	1/60
Versione con O-ring / O-ring version				
3320K1904R	G 1/2"	24x19 fil (Ø18)	8,58	1/60



ART. 3326

Valvola a squadra manuale con attacco per tubo ferro.
Versione cromata
Manual valve with thermostatic option for iron pipe.
Chrome-plated version

CODICE Code	TIPO Size	PREZZO Price €	CONF. Unit/Box
3326K0404	G 1/2"	7,33	1/60
3326K0505	G 3/4"	11,85	1/60
Versione con O-ring / O-ring version			
3326K0404R	G 1/2"	7,94	1/60
3326K0505R	G 3/4"	12,38	1/60



ART. 3325

Valvola manuale dritta termostattizzabile con attacco per tubo ferro.
Versione cromata
Straight manual valve with thermostatic option for iron pipe.
Chrome-plated version

CODICE Code	TIPO Size	PREZZO Price €	CONF. Unit/Box
3325K0404	G 1/2"	7,67	1/60
3325K0505	G 3/4"	12,30	1/60
Versione con O-ring / O-ring version			
3325K0404R	G 1/2"	8,29	1/60
3325K0505R	G 3/4"	12,83	1/60

VALVOLE MANUALI PER RADIATORI SERIE "EXCEL"

RADIATOR MANUAL VALVES "EXCEL" SERIES



ART. 3221EXCEL

Valvola manuale a squadra con attacco per tubo rame/Pe-x/multistrato
Angle manual valve for copper/Pe-x/multilayer pipe

CODICE Code	TIPO Size	ATTACCHI Connections	PREZZO Price €	CONF. Unit/Box
3221N0403EC	G 3/8"	1/2" - 16	5,08	10/60
3221N0404EC	G 1/2"	1/2" - 16	4,82	10/60
■ 3221K1904EC	G 1/2"	24x19 fil (Ø18)	6,44	1/60
Versione con O-ring / O-ring version				
3221N0403ECR	G 3/8"	1/2" - 16	5,69	10/60
3221N0404ECR	G 1/2"	1/2" - 16	5,63	10/60
■ 3221K1904ECR	G 1/2"	24x19 fil (Ø18)	7,11	1/60

■ versione cromata / chrome-plated version



ART. 3220EXCEL

Valvola manuale diritta con attacco per tubo rame/Pe-x/multistrato
Straight manual valve for copper/Pe-x/multilayer pipe

CODICE Code	TIPO Size	ATTACCHI Connections	PREZZO Price €	CONF. Unit/Box
3220N0403EC	G 3/8"	1/2" - 16	5,61	10/60
3220N0404EC	G 1/2"	1/2" - 16	5,85	10/60
■ 3220K1904EC	G 1/2"	24x19 fil (Ø18)	6,77	1/60
Versione con O-ring / O-ring version				
3220N0403ECR	G 3/8"	1/2" - 16	6,22	10/60
3220N0404ECR	G 1/2"	1/2" - 16	6,45	10/60
■ 3220K1904ECR	G 1/2"	24x19 fil (Ø18)	7,45	1/60

■ versione cromata / chrome-plated version



ART. 3226EXCEL

Valvola manuale a squadra con attacco per tubo ferro
Angle manual valve for iron pipe

CODICE Code	TIPO Size	PREZZO Price €	CONF. Unit/Box
3226N0303EC	G 3/8"	5,90	10/60
3226N0404EC	G 1/2"	5,18	10/60
● 3226N0505EC	G 3/4"	10,88	10/60
Versione con O-ring / O-ring version			
3226N0404ECR	G 1/2"	6,22	10/60
● 3226N0505ECR	G 3/4"	11,40	10/60



ART. 3225EXCEL

Valvola manuale diritta con attacco per tubo ferro
Straight manual valve for iron pipe

CODICE Code	TIPO Size	PREZZO Price €	CONF. Unit/Box
3225N0303EC	G 3/8"	6,06	10/60
3225N0404EC	G 1/2"	6,06	10/60
● 3225N0505EC	G 3/4"	12,74	10/60
Versione con O-ring / O-ring version			
3225N0404ECR	G 1/2"	6,66	10/60
● 3225N0505ECR	G 3/4"	13,26	10/60

DETENTORI PER RADIATORI SERIE "EXCEL"

LOCKSHIELDS RADIATORS "EXCEL" SERIES



ART. 3231EXCEL

Detentore a squadra con attacco per tubo rame/Pe-x/multistrato
Angle lockshield for copper/Pe-x/
multilayer pipe

CODICE Code	TIPO Size	ATTACCHI Connections	PREZZO Price €	CONF. Unit/Box
3231N0403EC	G 3/8"	1/2" - 16	4,55	10/60
3231N0404EC	G 1/2"	1/2" - 16	4,53	10/60
■ 3231K1904EC	G 1/2"	24x19 fil (Ø18)	6,15	1/60
Versione con O-ring / O-ring version				
3231N0403ECR	G 3/8"	1/2" - 16	5,22	10/60
3231N0404ECR	G 1/2"	1/2" - 16	5,45	10/60
■ 3231K1904ECR	G 1/2"	24x19 fil (Ø18)	6,91	1/60

■ versione cromata / chrome-plated version



ART. 3230EXCEL

Detentore diritto con attacco per tubo rame/Pe-x/multistrato
Straight lockshield for copper/Pe-x/
multilayer pipe

CODICE Code	TIPO Size	ATTACCHI Connections	PREZZO Price €	CONF. Unit/Box
3230N0403EC	G 3/8"	1/2" - 16	5,01	10/60
3230N0404EC	G 1/2"	1/2" - 16	5,39	10/60
■ 3230K1904EC	G 1/2"	24x19 fil (Ø18)	6,49	1/60
Versione con O-ring / O-ring version				
3230N0403ECR	G 3/8"	1/2" - 16	5,75	10/60
3230N0404ECR	G 1/2"	1/2" - 16	6,11	10/60
■ 3230K1904ECR	G 1/2"	24x19 fil (Ø18)	7,17	1/60

■ versione cromata / chrome-plated version



ART. 3236EXCEL

Detentore a squadra con attacco per tubo ferro
Angle lockshield for iron pipe

CODICE Code	TIPO Size	PREZZO Price €	CONF. Unit/Box
3236N0303EC	G 3/8"	4,97	10/60
3236N0404EC	G 1/2"	4,56	10/60
● 3236N0505EC*	G 3/4"	10,29	10/60
Versione con O-ring / O-ring version			
3236N0404ECR	G 1/2"	5,62	10/60
● 3236N0505ECR*	G 3/4"	10,81	10/60

* Con cappuccio nichelato / with nickel-plated cap



ART. 3235EXCEL

Detentore diritto con attacco per tubo ferro
Straight lockshield for iron pipe

CODICE Code	TIPO Size	PREZZO Price €	CONF. Unit/Box
3235N0303EC	G 3/8"	5,13	10/60
3235N0404EC	G 1/2"	5,13	10/60
● 3235N0505EC*	G 3/4"	11,59	10/60
Versione con O-ring / O-ring version			
3235N0404ECR	G 1/2"	5,80	10/60
● 3235N0505ECR*	G 3/4"	12,11	10/60

* Con cappuccio nichelato / with nickel-plated cap



ART. 3382K
Valvola manuale monotubo "DUOFLOW MAXIMA" ad ingresso acqua reversibile
Single pipe manual valve "DUOFLOW MAXIMA" with reversible flow inlet

CODICE Code	TIPO Size	ATTACCHI Connections	PREZZO Price €	CONF. Unit/Box
3382K1904	G 1/2"	24x19 fil (Ø18)	29,62	1/20

ART. 3382K

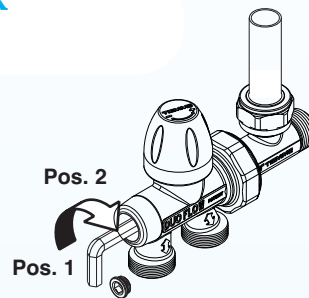

Ruotare di 180° in senso orario
Turn 180° clockwise



ART. 3385K
Valvola monotubo completa di sonda interna metallica (lunghezza 45 cm)
Single pipe valve with internal metallic probe (45 cm length)



CODICE Code	TIPO Size	ATTACCHI Connections	PREZZO Price €	CONF. Unit/Box
3385K1904	G 1/2"	24x19 fil (Ø18)	26,42	1/20

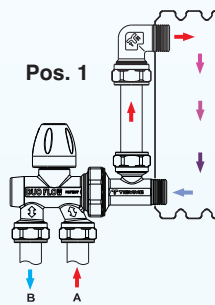

Collegamento standard
Standard connection

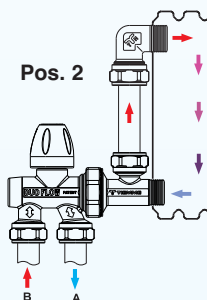

Collegamento con ingresso invertito
Reversed inlet connection



ART. 3383K
Valvola mono/bitubo "DUAL" ad ingresso acqua reversibile completa di sonda metallica Ø10 mm di lunghezza 45 cm
Single/double pipe valve "DUAL" with reversible flow inlet provided with Ø10 mm metallic probe 45 cm length

CODICE Code	TIPO Size	ATTACCHI Connections	PREZZO Price €	CONF. Unit/Box
3383K1904	G 1/2"	24x19 fil (Ø18)	26,42	1/20

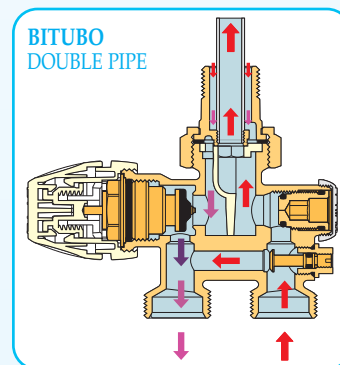
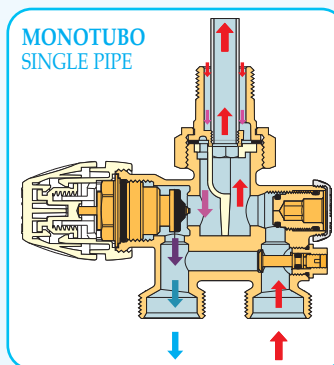

ART. 3382K - 3383K - 3385K

GUIDA ALLE CONNESSIONI CONNECTION GUIDE

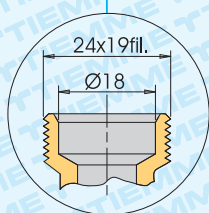
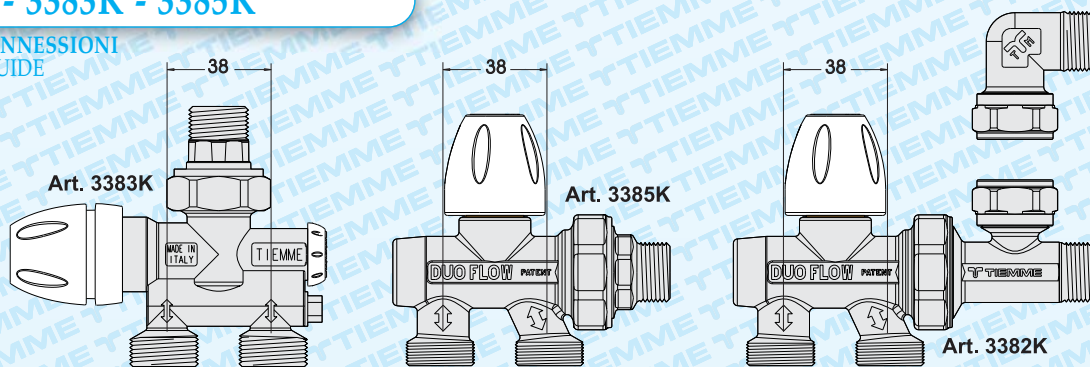

Art. 1716
Per tubo Pe-x
For Pe-x pipe

Art. 1666K
Per tubo multistrato
For multilayer pipe

Art. 1633K
Per tubo multistrato
For multilayer pipe

Art. 1243K
Per tubo rame
For copper pipe

Art. 1433K
Per tubo Pe-x
For Pe-x pipe

Art. 1859G0005
Adattatore per sede piana
Flat seat adaptor

Art. 1879K2419
Tappo
Cap

Per tabella giri di serraggio vedi pag 279 Cap. 20
For nut tightening table see pag 279 Chap. 20

VALVOLE E DISTRIBUTORI

SPECIAL VALVES



ART. 3370K
 Distributore con attacchi per tubi dal pavimento con portata al radiatore 50% - Attacchi 24x19 fil (Ø18) con interasse 38 mm per tubi dal pavimento - Attacco per tubo rame Ø 15 al radiatore
Distributor for pipes from the floor - Flow rate to the radiator 50% - Single pipe 24x19 tpi (Ø18) connection for floor pipes - Distance between centres 38 mm - Copper pipe connection Ø 15 to the radiator

CODICE Code	TIPO Size	ATTACCHI Connections	PREZZO Price €	CONF. Unit/Box
3370K1904	G 1/2"	24x19 fil (Ø18)	14,72	10/60



ART. 3375K
 Distributore con attacchi per tubi dal pavimento con portata al radiatore 100% - Attacchi 24x19 fil (Ø18) con interasse 38 mm per tubi dal pavimento - Attacco per tubo rame Ø 15 al radiatore
Distributor for pipes from the floor - Flow rate to the radiator 100% - Double pipe 24x19 tpi (Ø18) connection for floor pipes - Distance between centres 38 mm - Copper pipe connection Ø 15 to the radiator

CODICE Code	TIPO Size	ATTACCHI Connections	PREZZO Price €	CONF. Unit/Box
3375K1904	G 1/2"	24x19 fil (Ø18)	15,58	10/60



ART. 3371K
 Distributore con attacchi per tubi dalla parete con portata al radiatore 50% - Attacchi 24x19 (18) con interasse 38 mm per tubi dalla parete - Attacco per tubo rame Ø 15 al radiatore
Distributor for pipes from the wall - Flow rate to the radiator 50% - Single pipe 24x19 tpi (Ø18) connection for wall pipes - Distance between centres 38 mm - Copper pipe connection Ø 15 to the radiator

CODICE Code	TIPO Size	ATTACCHI Connections	PREZZO Price €	CONF. Unit/Box
3371K1904	G 1/2"	24x19 fil (Ø18)	22,67	10/60



ART. 3376K
 Distributore con attacchi per tubi dalla parete con portata al radiatore 100% - Attacchi 24x19 (18) con interasse 38 mm per tubi dalla parete - Attacco per tubo rame Ø 15 al radiatore
Distributor for pipes from the wall - Flow rate to the radiator 100% - Double pipe 24x19 tpi (Ø18) connection for wall pipes - Distance between centres 38 mm - Copper pipe connection Ø 15 to the radiator

CODICE Code	TIPO Size	ATTACCHI Connections	PREZZO Price €	CONF. Unit/Box
3376K1904	G 1/2"	24x19 fil (Ø18)	23,53	10/60

ART. 3370K - 3371K - 3375K - 3376K

GUIDA ALLE CONNESSIONI CONNECTION GUIDE

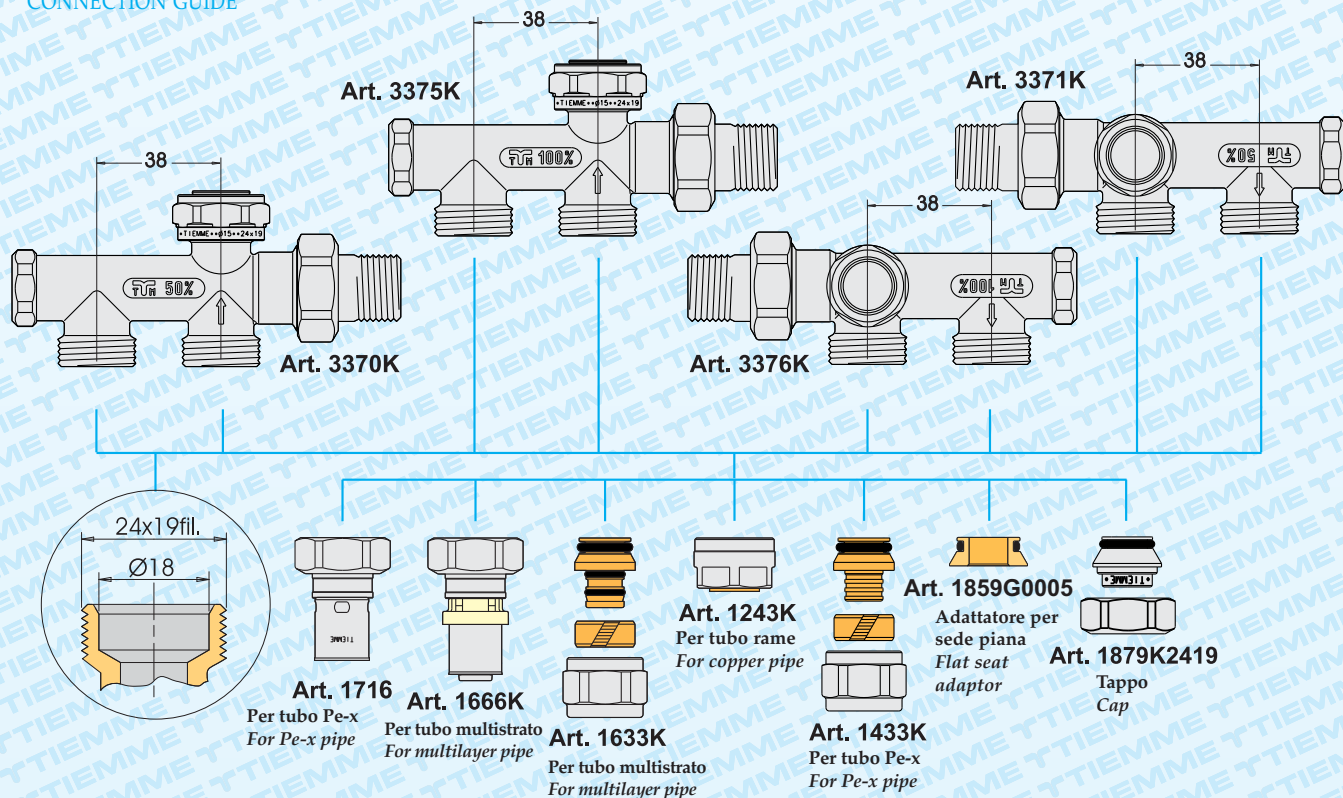

Per tabella giri di serraggio vedi pag 279 Cap. 20
 For nut tightening table see pag 279 Chap. 20

VALVOLE E DISTRIBUTORI

SPECIAL VALVES



ART. 3361K
Valvola a squadra termostattizzabile con attacco tubo rame Ø 15
Angle valve, thermostatic option, copper pipe Ø 15 connection

CODICE Code	TIPO Size	ATTACCHI Connections	PREZZO Price €	CONF. Unit/Box
3361K1504	G 1/2"	15	16,77	10/60

Fornibile anche nella versione con cappuccio di protezione da cantiere art. 3362K1504 / Available also with protection cap art. 3362K1504



ART. 3363K
Valvola a squadra termostattizzabile con attacco tubo rame Ø 15
Angle valve, thermostatic option, copper pipe Ø 15 connection

CODICE Code	TIPO Size	ATTACCHI Connections	PREZZO Price €	CONF. Unit/Box
3363K1504	G 1/2"	15	15,94	10/60

Fornibile anche nella versione con cappuccio di protezione da cantiere art. 3364K1504 / Available also with protection cap art. 3364K1504



ART. 1505C
Tubetto cromato Ø 15
Chrome-plated Ø 15 tube

CODICE Code	TIPO Size	PREZZO Price €	CONF. Unit/Box
1505C0015060	60 cm	2,94	10/500
1505C0015065	65 cm	3,93	10/1000
1505C0015090	90 cm	4,72	10/1000
1505C0015110	110 cm	5,21	10/750

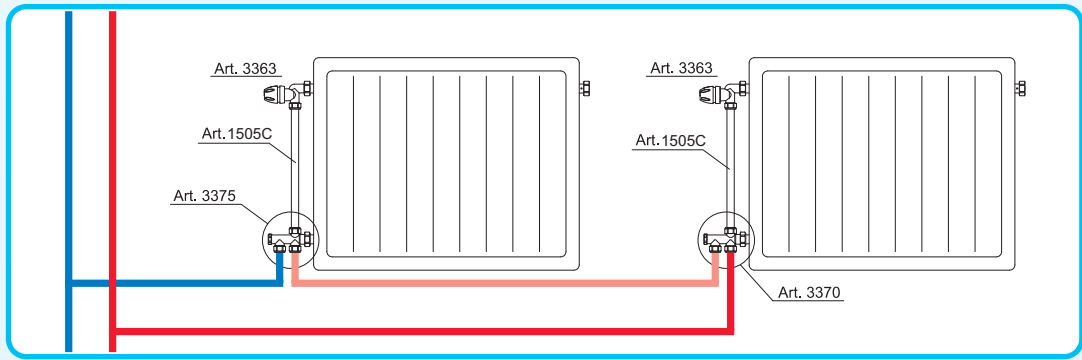
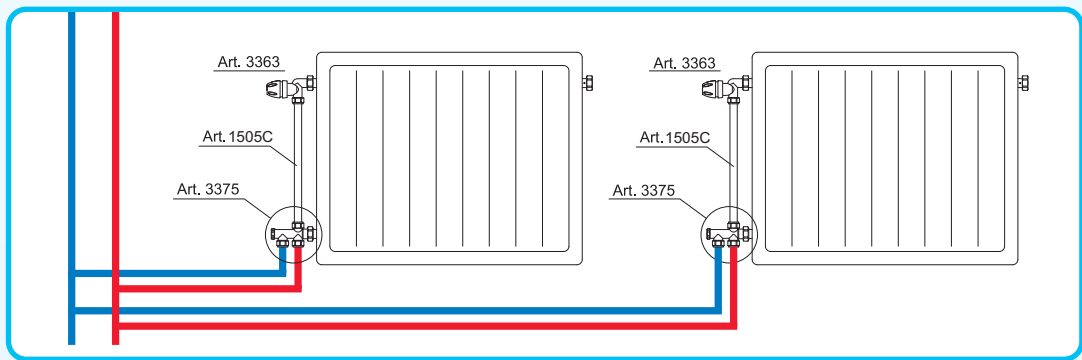

DISTRIBUTORI BITUBO

DOUBLE PIPES DISTRIBUTORS



ART. 3391

Distributore bitubo per piastre convettatrici con gruppo valvola termostatica incorporato. Attacchi per tubo da pavimento e raccordi per piastra da 3/4"x18 (Eurocono)
 Straight valve 3/4" for two-pipe systems steel panel radiators with thermostatic valve group 3/4"x18 (Euroconus). Radiator connection



ART. 3393

Distributore bitubo per piastre convettatrici con gruppo valvola termostatica incorporato. Attacchi per tubo da parete e raccordi per piastra da 3/4"x18 (Eurocono)
 Angle valve 3/4" for two-pipe systems steel panel radiators with thermostatic valve group 3/4"x18 (Euroconus). Radiator connection

CODICE Code	TIPO Size	PREZZO Price €	CONF. Unit/Box
3391N0505	3/4" Fem-3/4" Euroc.	13,18	15/45
3391K1905	3/4" Fem-24x19 fil	16,11	15/45

CODICE Code	TIPO Size	PREZZO Price €	CONF. Unit/Box
3393N0505	3/4" Fem-3/4" Euroc.	13,18	10/30
3393K1905	3/4" Fem-24x19 fil	16,11	10/30



ART. 3391BY

Distributore bitubo per piastre convettatrici con gruppo valvola termostatica incorporato e by-pass. Attacchi per tubo da pavimento e raccordi per piastra 3/4"x18 (Eurocono)
 Straight valve with by-pass 3/4" for two-pipe systems steel panel radiators with thermostatic valve group 3/4"x18 (Euroconus). Radiator connection



ART. 3393BY

Distributore bitubo per piastre convettatrici con gruppo valvola termostatica incorporato e by-pass. Attacchi per tubo da parete e raccordi per piastra da 3/4"x18 Eurocono
 Angle valve with by-pass 3/4" for two-pipe systems steel panel radiators with thermostatic valve group 3/4"x18 (Euroconus). Radiator connection

CON BY-PASS WITH BY-PASS

CODICE Code	TIPO Size	PREZZO Price €	CONF. Unit/Box
3391N0505BY	3/4" Fem-3/4" Euroc.	21,05	15/45
3391K1905BY	3/4" Fem-24x19 fil	25,72	15/45

CON BY-PASS WITH BY-PASS

CODICE Code	TIPO Size	PREZZO Price €	CONF. Unit/Box
3393N0505BY	3/4" Fem-3/4" Euroc.	21,05	10/30
3393K1905BY	3/4" Fem-24x19 fil	25,72	10/30



ART. 3390RID

Riduzione per attacchi 1/2" femmina
 Adaptor for radiators with 1/2" female connections

CODICE Code	TIPO Size	PREZZO Price €	CONF. Unit/Box
3390RID0504	3/4" x 1/2"	3,03	10/250

- versione nichelata / nickel-plated version
- versione cromata / chrome-plated version

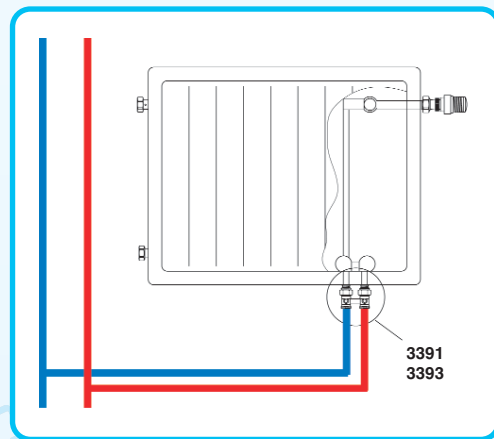

ART. 3391K-3393K

GUIDA ALLE CONNESSIONI CONNECTION GUIDE

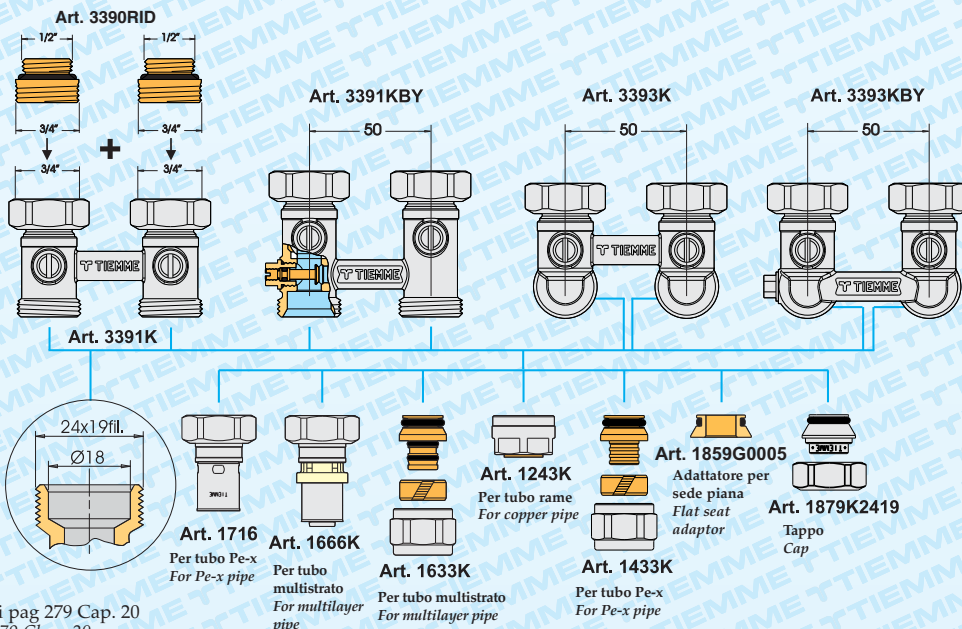

Per tabella giri di serraggio vedi pag 279 Cap. 20
 For nut tightenings table see pag 279 Chap. 20

ART. 3391N-3393N

GUIDA ALLE CONNESSIONI
FITTING GUIDE

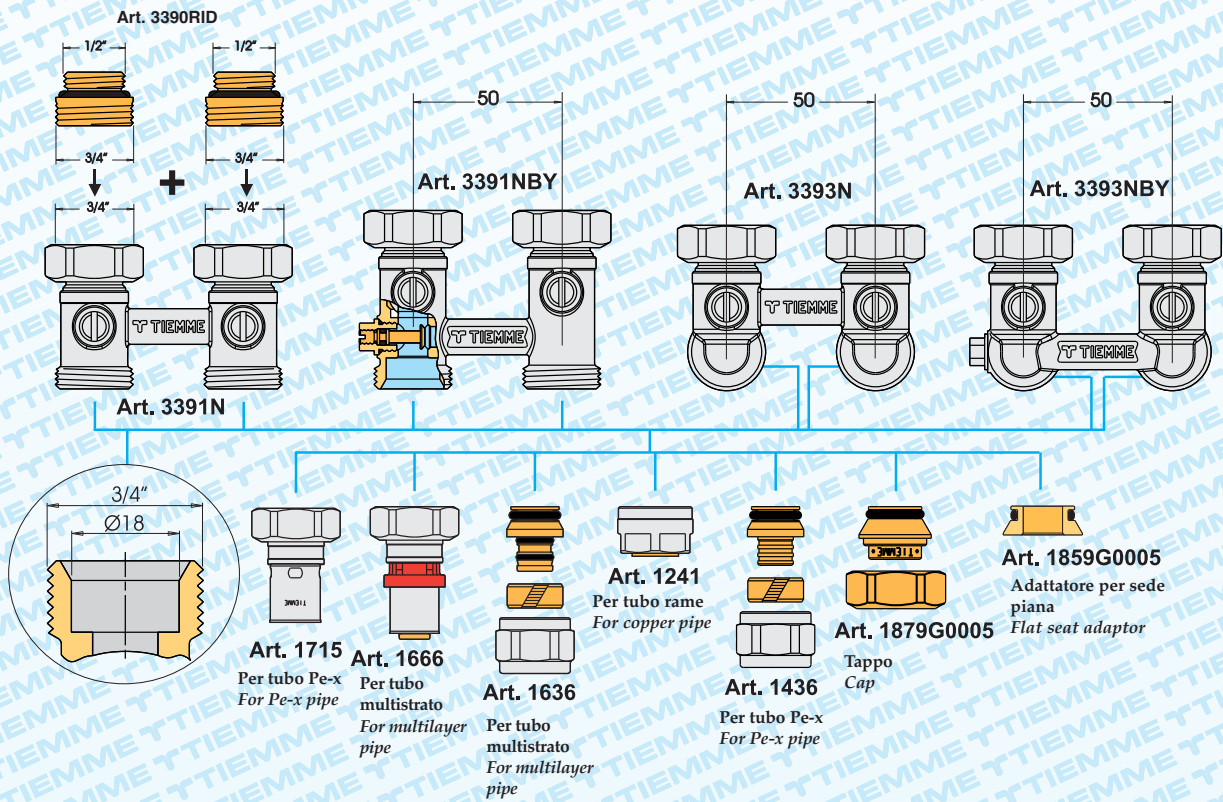



ART. 9550
Manopola per valvole termostattabili serie 3300
Plastic head for thermostatic valves series 3300

CODICE Code	TIPO Size	PREZZO Price €	CONF. Unit/Box
9550P0005IM		1,32	5/50



ART. 9552
Manopola per valvole manuali serie 3200
Plastic head for manual valves series 3200

CODICE Code	TIPO Size	PREZZO Price €	CONF. Unit/Box
9552P05IM		0,42	5/50



ART. 3340
Rosone universale
Universal cover for pipe

CODICE Code	TIPO Size	PREZZO Price €	CONF. Unit/Box
3340N0003	Ø10 - Ø18	0,68	10



ART. 3338
Bocchettone con guarnizione
Tail pieces with seal

CODICE Code	TIPO Size	PREZZO Price €	CONF. Unit/Box
3338N0003	3/8"	2,96	5/100
3338N0004	1/2"	3,05	5/100
3338N0005	3/4"	4,89	5/100



ART. 3342
Rosone universale doppio con interasse 38 mm
Double universal cover for pipe with distance between centres 38 mm

CODICE Code	TIPO Size	PREZZO Price €	CONF. Unit/Box
3342P151838	Ø10 - Ø18	1,98	1/50



ART. 3345N *
Dado + ogiva in ottone con attacco ferro G1/2" - per tubo rame
Nut with brass rings, iron pipe connection G1/2" - for copper pipe

CODICE Code	TIPO Size	PREZZO Price €	CONF. Unit/Box
3345N0410	10 x 1/2"	1,86	10
3345N0412	12 x 1/2"	1,84	10
3345N0414	14 x 1/2"	1,80	10
3345N0415	15 x 1/2"	1,80	10
3345N0416	16 x 1/2"	1,80	10

* utilizzare con valvole e detentori serie 3300
to be used with valves and lockshields 3300 series



ART. 9760
Chiave esagonale per DUO FLOW
Exagonal spanner for DUO FLOW

CODICE Code	TIPO Size	PREZZO Price €	CONF. Unit/Box
9760Z09	unica - single	1,19	10



ART. 1829Z
Coppia staffette fissaggio radiatore
Couple of brackets for radiators



CODICE Code	TIPO Size	PREZZO Price €	CONF. Unit/Box
1829Z092SET	unica - single	1,63	25/100



ART. 3351
Valvola di sfiato per radiatori con anello di pretenuta
Air vent valve with O-ring for radiators

CODICE Code	TIPO Size	PREZZO Price €	CONF. Unit/Box
3351N0002	1/4"	vedi cap. 24	10/500
3351N0003	3/8"	vedi cap. 24	10/500
3351N0004	1/2"	vedi cap. 24	10/500



ART. 3350
Valvola di sfiato per radiatori
Air vent valve for radiators

CODICE Code	TIPO Size	PREZZO Price €	CONF. Unit/Box
3350N0001	1/8"	vedi cap. 24	10/500
3350N0002	1/4"	vedi cap. 24	10/500
3350N0003	3/8"	vedi cap. 24	10/500
3350N0004	1/2"	vedi cap. 24	10/500



ART. 3352
Valvola di sfiato per radiatori con taglio cacciavite
Air vent valve with screwdriver cut for radiators

CODICE Code	TIPO Size	PREZZO Price €	CONF. Unit/Box
3352C0004	1/2"	vedi cap. 24	10/500

